



# SkyTracker™ Camera Mount Instruction Manual

Product #3302B, #3302W and #3303

# Table of Content

Table of Content.....	2
1. SkyTracker™ Camera Mount Overview .....	3
2. SkyTracker™ Camera Mount Assembly.....	3
2.1. Introduction .....	3
2.2. Parts List.....	4
2.3. Assembly Terms .....	5
2.4. SkyTracker™ Camera Mount Assembly .....	6
3. Maintenance and Servicing .....	11
3.1. Maintenance .....	11
3.2. iOptron Customer Service.....	11
3.3. Product End of Life Disposal Instructions.....	11
3.4. Battery Replacement and Disposal Instructions.....	11
Appendix A. Technical Specifications.....	12
IOPTRON ONE YEAR TELESCOPE, MOUNT, AND CONTROLLER WARRANTY.....	13



## WARNING!

***NEVER USE A TELESCOPE TO LOOK AT THE SUN WITHOUT A PROPER FILTER!  
Looking at or near the Sun will cause instant and irreversible damage to your eye.  
Children should always have adult supervision while observing.***

Rev.2.0

iOptron reserves the rights to revise this instruction without notice. Actual color/contents/design may differ from those described in this instruction.

# 1. SkyTracker™ Camera Mount Overview

Thank you for choosing the new iOptron SkyTracker™ camera mount for astrophotography. This portable mount makes it easy to take long exposures of the night sky without streaking or star trailing.

The SkyTracker™ mount is simple to set up. Just attach the unit to a camera tripod with 3/8" thread. Then slide and lock your digital camera into the saddle. Align SkyTracker™ mount to the Pole Star through the polar sight hole on the mount, or using an iOptron AccuAligning™ dark field illuminated polar scope, with built in latitude and azimuth adjusters. Then turn on the motor and it keeps your camera tracking at the same speed the earth rotates! The unique DC servo motor keeps your camera in motion to avoid star trails and allows you to take long exposures for beautiful images of the night sky.

## Features:

- Attaches to a camera tripod with 3/8" thread
- Accepts cameras weighing up to 7.7 lbs (3.5 kg)
- Auto-tracking for smooth camera motion perfect for long-term exposures
- Cast aluminum body with plastic spray finish
- Built in latitude and azimuth adjusters for easy polar alignment
- Built in compass
- Reversible mounting post for both 3/8" and 1/4" threaded ball head mounting
- Includes iOptron AccuAligning™ dark-field illuminated polar scope (#3302B and #3302W only)
- Up to 24 hours of operation on 4 AA batteries
- Padded carry bag included
- Optional ball heads available separately (#3305)
- Optional AC/DC adapter (#8417)
- Optional tripod (#3101)

# 2. SkyTracker™ Camera Mount Assembly

## 2.1. Introduction

You have just purchased a tracking camera mount that is capable of taking you to a new level of astrophotography. When aligned the polar axis of the SkyTracker™ camera mount with the celestial North Pole (CNP), or celestial South Pole (CSP), the mount will provide rotation matching the celestial sphere rotation around the Earth. Since all celestial objects appear to rotate around the CNP, or CSP, the polar axis allows the mount to rotate with the celestial sphere and provide accurate tracking for visual observations and astrophotography.

The AccuAligning™ polar scope, along with the Quick Polar Alignment procedure, will provide an easy and accurate polar alignment for the mount.

The SkyTracker mount is a totally new camera mount for astrophotography. The following sections of this manual provide the detailed steps required to successfully set up and operate the SkyTracker™ mount.

## 2.2. Parts List<sup>1</sup>

### PARTS INCLUDED:

The SkyTracker™ camera mount shipping box contains:

- SkyTracker™ camera mount
- Padded carry bag
- AccuAligning™ dark field illuminated polar scope (for models #3302B and #3302W only)



Figure 1. Parts in a SkyTracker™ #3302 package

### PARTS NEEDED:

The following parts are needed to take astrophotography but are not included in the package:

- A sturdy tripod with 3/8" thread. If your tripod only has a 1/4" thread, you need a 1/4" to 3/8" tripod adapter screw
- Fresh 4 AA batteries or an AC/DC adapter
- Ball head adapter
- DLSR camera

### YOU MAY NEED IT FOR POLAR ALIGNMENT:

- iPhone/iPad app for accurate polar alignment (<https://itunes.apple.com/us/app/ioprotron-polar-scope/id564078961?mt=8>)
- Or other application/program to calculate the pole star position. Please refer to FAQ session under Support at <http://www.ioprotron.com> for more information.

### ONLINE CONTENTS *(click under "Support" menu)* [www.ioprotron.com](http://www.ioprotron.com)

- This manual
- Tips for set up
- Reviews and feedback from other customers

<sup>1</sup> US market only. Actual contents and appearances may vary.

**2.3. Assembly Terms**



Figure 2. Front view of a SkyTracker

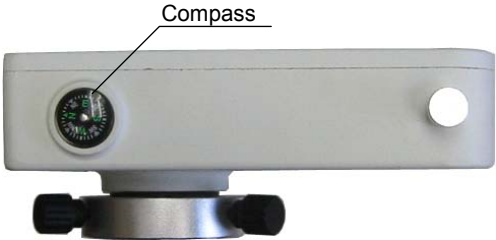

Figure 3. Top view of a SkyTracker

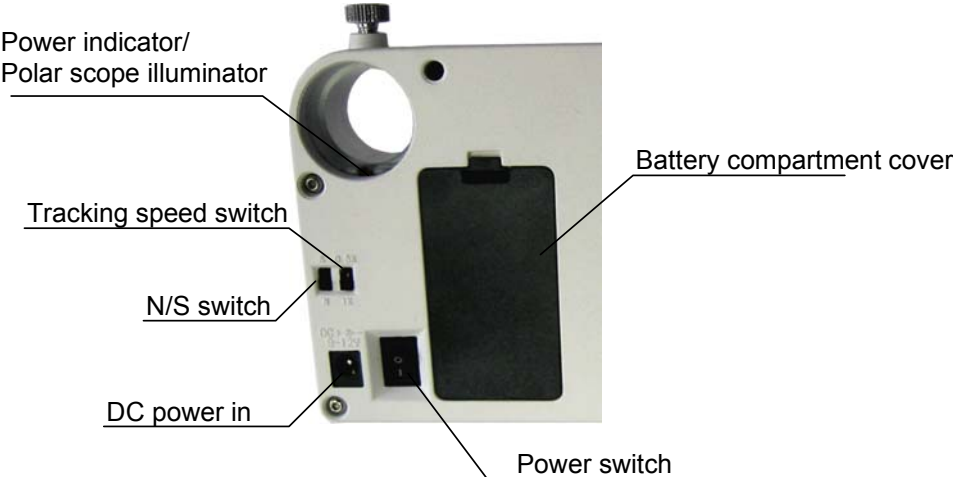

Figure 4. Part of back view of a SkyTracker

## 2.4. SkyTracker™ Camera Mount Assembly

**NOTE:** The SkyTracker™ mount is a precision astronomical instrument. It is highly recommended that you read the entire manual and become familiar with the nomenclature and functions of all components before starting the assembly.

### STEP 1. Install batteries

The battery compartment is located at the back of the SkyTracker™ mount (**Figure 4**). Lift the battery compartment cover and gently pull out the battery holder from the compartment. Insert 4 fresh AA batteries (not included) into the holder (**Figure 5a**). Since it is a tight fit, you may find that you cannot put the battery cover back due to the wires. Straighten the battery holder wires, slide the battery holder back into the battery compartment and leave the wires outside, as shown in **Figure 5b**. Then push the battery holder wires down into the battery compartment, as shown in **Figure 5c**. Place the battery cover back onto the battery compartment and push the cover hook up to secure the battery cover (**Figure 5d**)

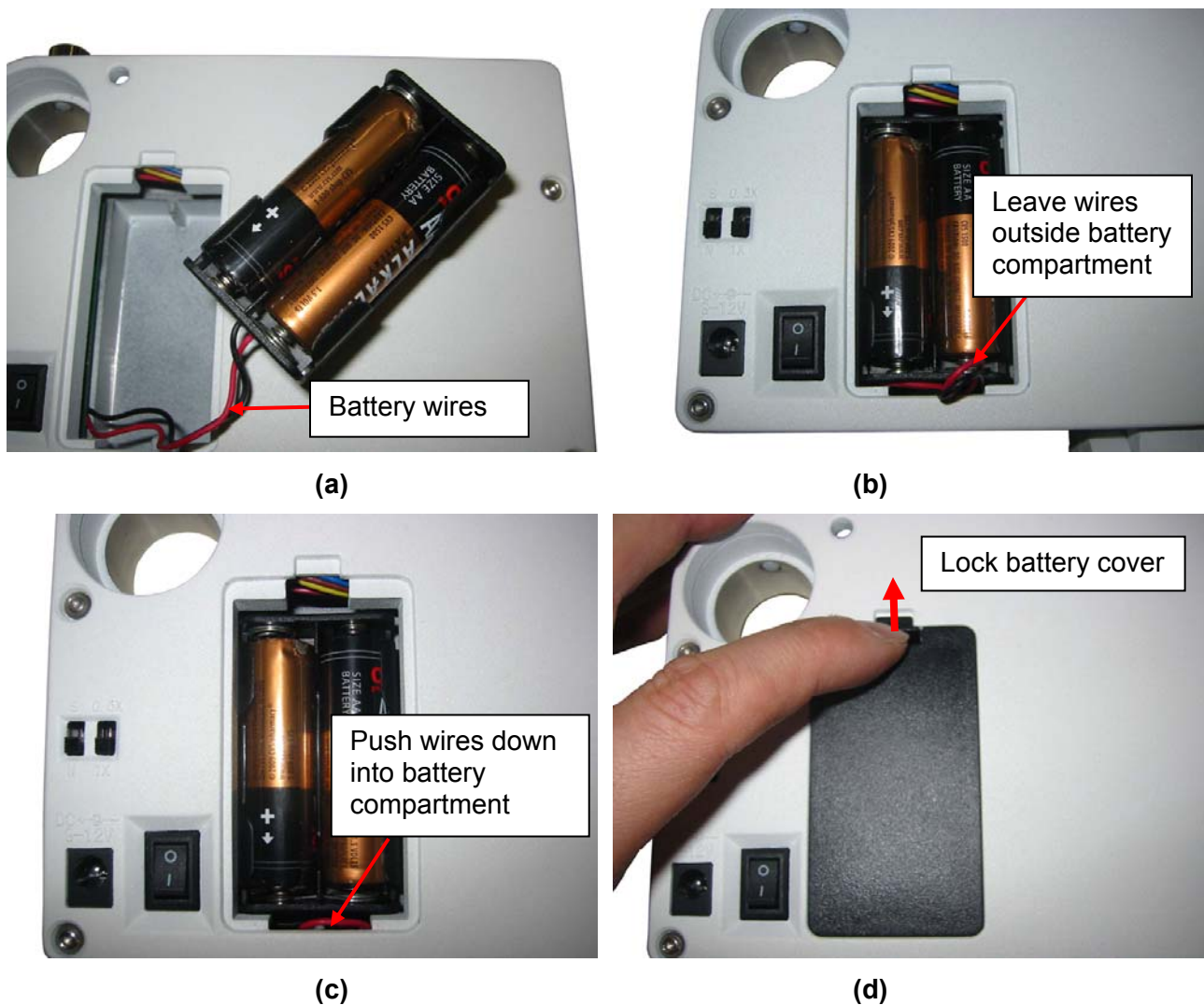

Figure 5. Install batteries

## STEP 2. Attach the SkyTracker™ Mount

Carefully thread the SkyTracker™ mount onto your tripod and make sure it is securely tightened. The mount base has a 3/8" threaded socket. If your tripod only has a 1/4" threaded post, a 1/4" to 3/8" tripod adapter screw (not included) is needed, as shown in **Figure 6**.



Figure 6. Install SkyTracker onto a tripod

## STEP 3. Set the SkyTracker™ mount

Release Latitude Lock a half turn. Set the latitude at zero mark (**Figure 7**) by turning the Latitude Adjustment Screw and retighten the Latitude Lock. Place the tripod to make the SkyTracker™ mount face north. Level the mount. Release Azimuth Locking Screw and turn the camera mount to make the compass N-S perpendicular to the mount front edge (**Figure 8**). You may need to tap the compass lightly to make the compass move freely.

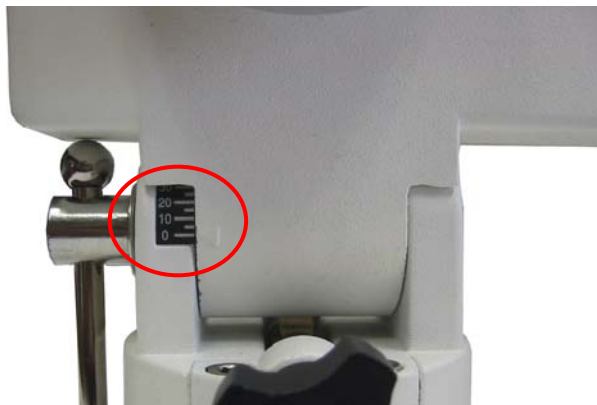

Figure 7. Set latitude to zero mark

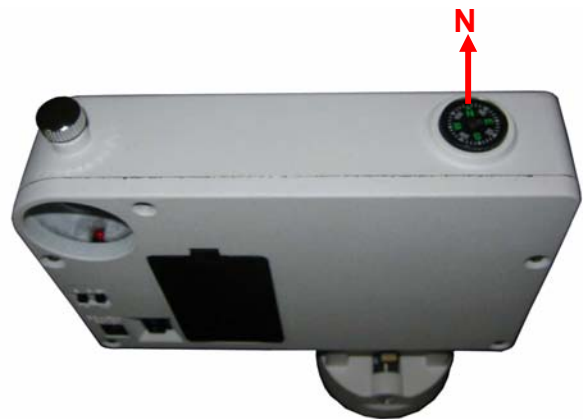

Figure 8. Face the mount north

## STEP 4. Set the latitude and find the Polaris

Release Latitude Lock a half turn. Set the latitude at your current latitude by turn the Latitude adjustment screw and retighten the Latitude lock, as indicated in **Figure 9**. You may find your current latitude from your smart phone or internet using your current address. If the north pointing and the latitude set are correct, you should be able to find the Polaris through the Polar Sight Hole. Center the Polaris inside the Polar Sight Hole as good as possible for the polar alignment. Retighten all the screws and locks.

For those located in the southern hemisphere, use Sigma Octantis in Octans as the pole star.



Figure 9. Set current latitude

### STEP 5. Easy Polar Alignment

This STEP will discuss how to use iOptron's AccuAligning™ dark field illuminated polar scope (**Figure 10**) for easy and accurate polar alignment. You may skip this part and directly go to **STEP 6**, if your model does not equipped with a polar scope or can't see pole star. In order for the SkyTracker™ mount tracking properly, it has to be accurately polar aligned. This is achieved by making the polar axis of the mount parallel to that of the Earth's axis of rotation.

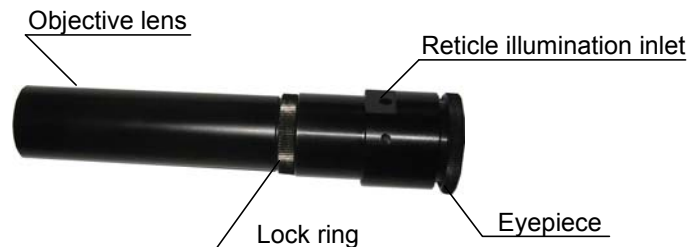

Figure 10. AccuAligning™ dark field illuminated polar scope

Before installing the polar scope onto the mount, face the polar scope to a bright source, such as the sky (but not the SUN) or a lamp from distant. Adjust the eyepiece to focus the reticle pattern. Then face the polar scope to a distant object and look through the eyepiece. If you can not see the distant object clearly, the polar scope is not focused for your eyesight. Release a few turns of the Lock ring. Turn the Objective lens until the image is focused. Retighten the Lock ring.

Turn the Polar Scope Lock Screw until it does not intrude into the Polar Scope Mounting Hole. The flat surface inside the mounting hole is for polar scope alignment and the LED acts as both the power indicator and the illuminating light for the polar scope reticle, as shown in **Figure 11**. Gently insert the polar scope into the Polar Scope Mounting Hole with the flat platoon on the polar scope face down. Push the polar scope all the way in so the flat surfaces inside the hole will align to the flat platoon on the polar scope and the LED will sit right to the little opening on the flat platoon. Finger tighten (not too tight) the Polar Scope Lock Screw (**Figure 12**).





Figure 11. Release polar scope lock screw



Figure 12. Installed polar scope

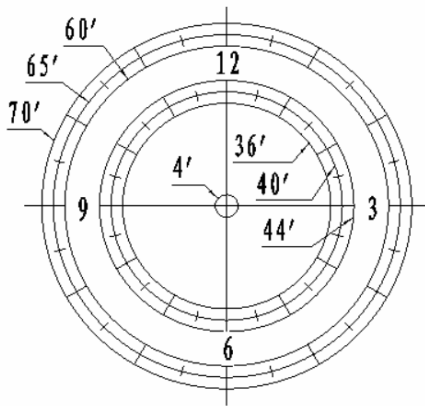

Figure 13. Polar scope dial

Press the power switch on the mount to turn the SkyTracker™ mount on. Look through the polar scope eyepiece. Adjust the

eyepiece to bring the reticle dial in focus. As indicated in **Figure 13**, the Polar Scope Dial has been divided into 12 hours along the angular direction with half-hour tics. There are 2 groups, 6 concentric circles marked from 36' to 44' and 60' to 70', respectively. The 36' to 44' concentric circles are used for polar alignment in the northern hemisphere using Polaris.

While the 60' to 70' circles are used for polar alignment in the southern hemisphere using Sigma Octantis.

To maximize the benefits of the iOptron polar scope for polar alignment, you need to know where the Polaris is in the northern hemisphere. You may find this information via an iPhone/iPad app (iOptron Polar Scope in Apple iTunes store). Shown in **Figure 14** is a screen shot of an iPhone chart. For example, on December 3, 2012, 12:48:36 in Boston, USA (Lat N42°30'28" and Long W71°08'49"), the Polaris Position is 10hr 24.1m and  $r = 40.8\text{min}$  (the green dot on the chart).

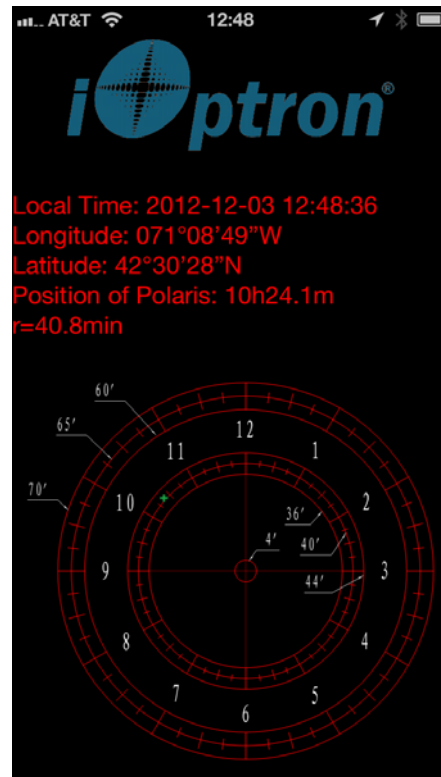

Figure 14. Polar scope chart on an iPhone

Adjust the mount in latitude (using Latitude Adjustment Screw) and azimuth (heading, tuning the mount by releasing Azimuth Locking Screw) direction to place Polaris in the same position on the Polar Scope Dial as indicated on your iPhone/iPad screen. In this case, the Polaris will be located at a radius of 40.8' and an angle of 10 hour 24.1 minute.

If you don't have an iPhone/iPad, you still can get a better polar alignment using other program/software to calculate the pole star position.

### STEP 6. Install ball head

Take off the Camera Mounting Block from the SkyTracker mount by releasing two thumb screws that hold the Camera Mounting Block in place, as indicated in **Figure 15**. Mount the ball head (available as accessory, #3305) onto the Camera Mounting Block by threading it onto the Brass Central Insert (**Figure 16**). Make sure they are tightened enough that there is no relative movement between the mounting block and ball head. Reinstall the mounting block with ball head back to the SkyTracker mount. Tighten the thumb screws to make sure that the mounting block will not slip.



Figure 15. Remove camera mounting block



Figure 16. Install ball head



Figure 17. SkyTracker with Polar Scope and a ball head installed

### STEP 7. Mount a camera and start SkyTracking

Install a DSLR camera onto the ball head and point the camera to the sky you are interested in. Make sure all the screws/locks are tightened. Select S/N switch based on your location. Select 1X or 1/2 tracking speed. Double check the polar alignment and realign it if needed. Turn the power switch on and enjoy the SkyTracking.

## 3. Maintenance and Servicing

### 3.1. Maintenance

The SkyTracker™ camera mount is designed to be maintenance free. Do not overload the mount. Do not drop the mount. This will damage the mount or degrade the tracking accuracy permanently. Use a damp cloth to clean the mount if necessary. Do not use solvent.

If your mount is not to be used for an extended period, remove the battery from the mount.

### 3.2. iOptron Customer Service

If you have any question concerning your mount, contact iOptron Customer Service Department. Customer Service hours are 9:00 AM to 5:00 PM, Eastern Time, Monday through Friday. In the unlikely event that the mount requires factory servicing or repairing, write or call iOptron Customer Service Department first to receive an RMA# before returning the mount to the factory. Please provide details as to the nature of the problem as well as your name, address, e-mail address, purchase info and daytime telephone number. We have found that most problems can be resolved by e-mails or telephone calls. So please contact iOptron first to avoid returning the mount for repair.

It is recommended to send technical questions to [support@ioptron.com](mailto:support@ioptron.com) or call in the U.S. 1.781.569.0200.

### 3.3. Product End of Life Disposal Instructions



This electronic product is subject to disposal and recycling regulations that vary by country and region. It is your responsibility to recycle your electronic equipment per your local environmental laws and regulations to ensure that it will be recycled in a manner that protects human health and the environment. To find out where you can drop off your waste equipment for recycling, please contact your local waste recycle/disposal service or the product representative.

### 3.4. Battery Replacement and Disposal Instructions



Battery Disposal- Batteries contain chemicals that, if released, may affect the environment and human health. Batteries should be collected separately for recycling, and recycled at a local hazardous material disposal location adhering to your country and local government regulations. To find out where you can drop off your waste battery for recycling, please contact your local waste disposal service or the product representative.

## Appendix A. Technical Specifications

Mount	Ultra compact EQ
Payload (MAX)	7.7 lbs (3.5kg)
Mount weight	2.6 lbs (1.2kg) w/o battery
Body material	Cast aluminum
Latitude adjustment range	0° ~ 70°
Worm wheel	Φ80mm, 156 teeth aluminum alloy
Worm gear	Φ11mm, brass
Bearing	4 pieces
Motor drive	DC servo
Tracking	R.A. automatic
Tracking speed	1X Cel, 1/2 Cel, N/S
Polar sight hole	~ 8.5° FOV
Polar scope	6° FOV with dark field illuminated (optional for #3303)
Power consumption	DC 4.8 ~ 6V, 0.06A at Max load
Power requirement	4 AA batteries, or External DC 9 ~12V, 500mA
Duration of operation	24 hours at 20°C
Built in accessory	Latitude and azimuth adjustor, Compass
Dimensions	153 x 104 x 58 mm
Operation Temperature	-10~40°C
Base connect	3/8" threaded socket
Warranty	One year limited

## IOPTRON ONE YEAR TELESCOPE, MOUNT, AND CONTROLLER WARRANTY

A. iOptron warrants your telescope, mount, or controller to be free from defects in materials and workmanship for one year. iOptron will repair or replace such product or part which, upon inspection by iOptron, is found to be defective in materials or workmanship. As a condition to the obligation of iOptron to repair or replace such product, the product must be returned to iOptron together with proof-of-purchase satisfactory to iOptron.

B. The Proper Return Merchant Authorization Number must be obtained from iOptron in advance of return. Call iOptron at 1.781.569.0200 to receive the RMA number to be displayed on the outside of your shipping container.

All returns must be accompanied by a written statement stating the name, address, and daytime telephone number of the owner, together with a brief description of any claimed defects. Parts or product for which replacement is made shall become the property of iOptron.

The customer shall be responsible for all costs of transportation and insurance, both to and from the factory of iOptron, and shall be required to prepay such costs.

iOptron shall use reasonable efforts to repair or replace any telescope, mount, or controller covered by this warranty within thirty days of receipt. In the event repair or replacement shall require more than thirty days, iOptron shall notify the customer accordingly. iOptron reserves the right to replace any product which has been discontinued from its product line with a new product of comparable value and function.

This warranty shall be void and of no force of effect in the event a covered product has been modified in design or function, or subjected to abuse, misuse, mishandling or unauthorized repair. Further, product malfunction or deterioration due to normal wear is not covered by this warranty.

IOPTRON DISCLAIMS ANY WARRANTIES, EXPRESS OR IMPLIED, WHETHER OF MERCHANTABILITY OF FITNESS FOR A PARTICULAR USE, EXCEPT AS EXPRESSLY SET FORTH HERE. THE SOLE OBLIGATION OF IOPTRON UNDER THIS LIMITED WARRANTY SHALL BE TO REPAIR OR REPLACE THE COVERED PRODUCT, IN ACCORDANCE WITH THE TERMS SET FORTH HERE. IOPTRON EXPRESSLY DISCLAIMS ANY LOST PROFITS, GENERAL, SPECIAL, INDIRECT OR CONSEQUENTIAL DAMAGES WHICH MAY RESULT FROM BREACH OF ANY WARRANTY, OR ARISING OUT OF THE USE OR INABILITY TO USE ANY IOPTRON PRODUCT. ANY WARRANTIES WHICH ARE IMPLIED AND WHICH CANNOT BE DISCLAIMED SHALL BE LIMITED IN DURATION TO A TERM OF ONE YEAR FROM THE DATE OF ORIGINAL RETAIL PURCHASE.

Some states do not allow the exclusion or limitation of incidental or consequential damages or limitation on how long an implied warranty lasts, so the above limitations and exclusions may not apply to you.

This warranty gives you specific legal rights, and you may also have other rights which vary from state to state.

iOptron reserves the right to modify or discontinue, without prior notice to you, any model or style telescope.

If warranty problems arise, or if you need assistance in using your telescope, mount, or controller contact:

iOptron Corporation  
Customer Service Department  
6E Gill Street  
Woburn, MA 01801  
[www.ioptron.com](http://www.ioptron.com)  
support@ioptron.com  
Tel. (781)569-0200  
Fax. (781)935-2860  
Monday-Friday 9AM-5PM EST

NOTE: This warranty is valid to U.S.A. and Canadian customers who have purchased this product from an authorized iOptron dealer in the U.S.A. or Canada or directly from iOptron. Warranty outside the U.S.A. and Canada is valid only to customers who purchased from an iOptron Distributor or Authorized iOptron Dealer in the specific country. Please contact them for any warranty.